

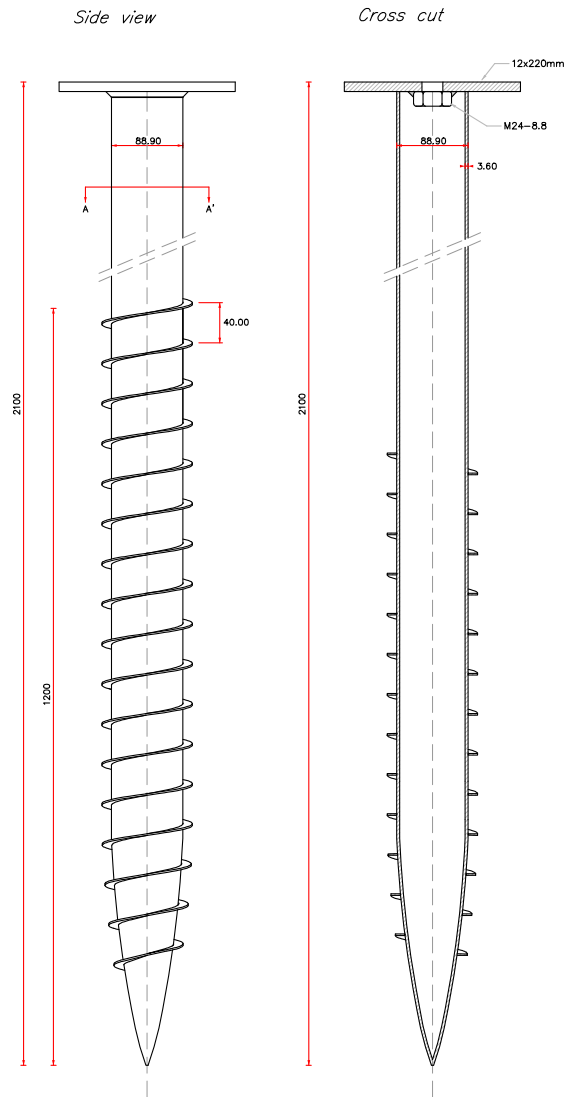

Art. no:	31047
Weight:	19,10 kg
Dimensions:	Pipe: 88,9 x 3,6 x 2100 mm Flange: 12,0 x 220 mm
Materials:	Steel Type Pipe: S235 Steel Type Flange: S355 Surface treatment: Galvanized according to DIN EN ISO 1461
Installation:	Electric Ground Screw Driving Machine (Art.No: 12001) Pneumatic Ground Screw Driving Machine (Art.No: 12005) Hydraulic Ground Screw Driving Machine (Art.No: 12090)
Use:	Light construction e.g. porches, garden rooms and modular homes.
Fixation:	M16 / M24 Bolts

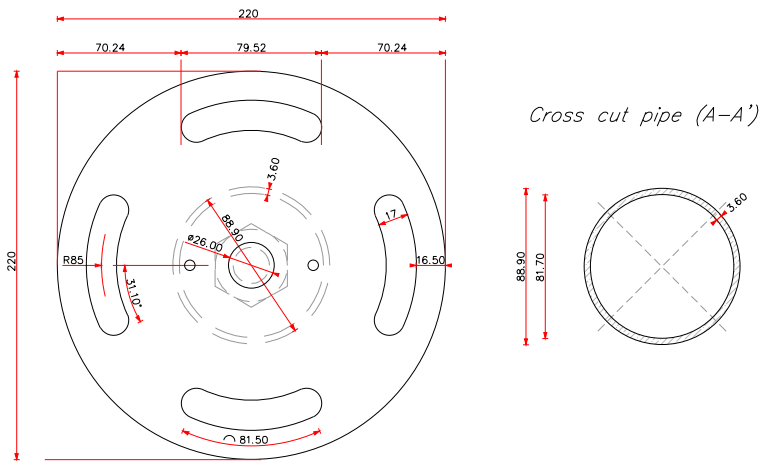

Part 1 – Top view flange



Drawing description	PRO-SERIES GROUND SCREW Ø89 x 2100mm	
Date	Signed	Sheet number
12/2018	DVDE	3 of 3
Drawing number	Format	Document status
31047-V1	A4	DEF.

FIRST BASE GROUND SCREWS
Patersweg 2, 5406 XJ
Uden, Holland.

info@firstbasegroundscrews.com
www.firstbasegroundscrews.com
0031 413 432 052

Products to combine:

- 17021 – POLEHOLDER M20
- 17022 – L-BRACKET M16 80mm
- 17023 – L-BRACKET M16 160mm

[Click here](#) for the FIRST BASE Load Capacity Chart